

REVISION RECORD			
REV.	CONTENT	MOD.	DATE
△	初版发行		

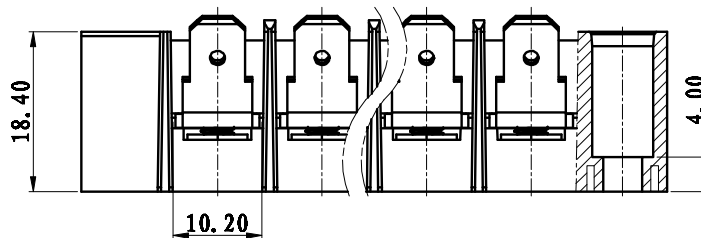

NOTES:
 Pitch : 12.0mm
 Rated Voltage : 600V
 Rated Current : 25A
 Withstand Voltage :
 AC3000V for 1 minute
 Insulation Resistance :
 1000MΩ / DC1000V
 Using Temperature Range :
 -40℃ ~ +105℃
 Suitable Electric Wire : 22-14 AWG
 Screw Torque Value : M4/1.2Nm

技术要求:
 间距: 12.0mm
 额定电压: 600V
 额定电流: 25A
 耐电压值: AC3000V/min
 绝缘阻抗: 1000MΩ/DC1000V
 使用条件: -40℃~+105℃
 适用线规: 22-14 AWG
 螺丝扭矩: M4/1.2Nm

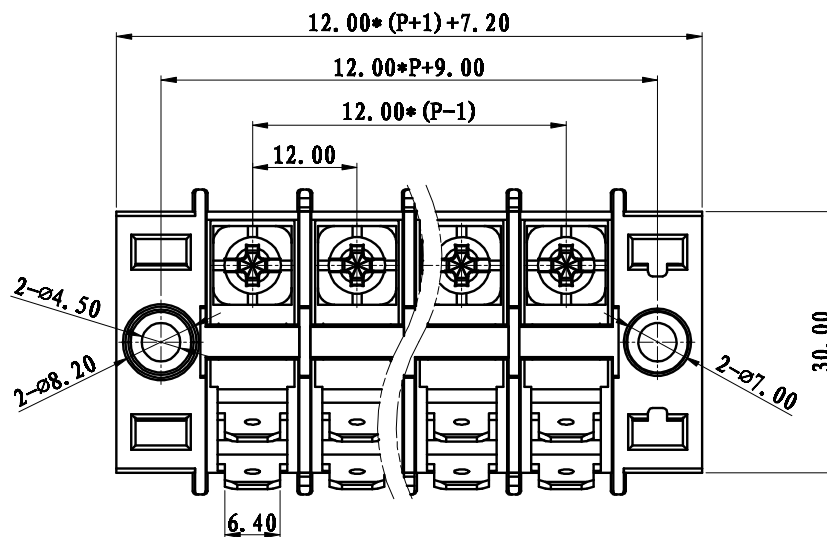
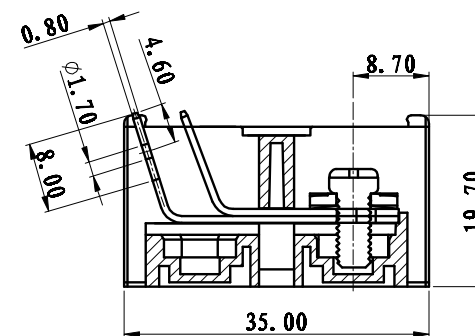

	pitch dimension			Nominal dimension					— /
	over 0	over 6	over 10	over 0	over 30	over 60	over 100	over 150	
variable range	to 6	to 10	to 24	to 30	to 60	to 100	to 150		▱ ○
Tolerance	±0.1	±0.15	±0.25	±0.2	±0.3	±0.5	±0.7	±1.0	0.05/10

4	M4*9-10*10	SPFFA409073V	P	碳钢	镀锌
3	M4外六角螺母	SM00A000004V	P	铁	镀锌
2	JX0-66-导电件1	6JX0BDD166AV	P	黄铜	镀镍
1	TB1-25XX-A本体	6TB1B072XX0V	1	PC	
NO.	NAME OF PART	NO. OF PART	QTY	MATERIAL	NOTES
DES.	LDD	DATE	2015/05/07	UNITS	mm
CHK.	DATE	SIZE	A4	THIRD ANGLE PROJECTION	
APP.	DATE	SCALE	1:1	DWG NO.	SP-2-6TB1020
上海有乐电气有限公司 Shanghai YouLe Electric CO.,LTD				TITLE	TB1-25XX-2D-1Y-00A TB1-25XX-B成品
					SHEET 1 of 1
					REV: Y0